

Layher Event Systems

Complete Range

Quality Management
certified according to
DIN EN ISO 9001:2000
by TÜV-CERT

Event Systems

V a r i a b l e . S a f e . F a s t .

Complete Range Layher Event Systems



Layher® 

More Possibilities. The Scaffolding System.

Layher "Live"

The Layher Event System Range.

2





Layher Event Systems

The largest complete range – available worldwide.

4

The basis for all Event Systems – Layher Allround® Scaffolding

Your benefits

- ▶ Very fast and very easy assembly
- ▶ Maximum flexibility and safety
- ▶ Low weight and transport volume
- ▶ Top quality standards and lasting value – made in Germany
- ▶ Available in steel and aluminium
- ▶ More than 60 years of experience in scaffolding production
- ▶ More than 20 years of experience in Event design



06
Truss Systems



07
Stage 7 x 4
"Verona"



08
Stage 9 x 6
"Madrid"

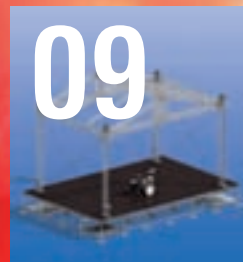

09
Stage 11 x 7
"Sydney"



10
Stage 11 x 9
"London"



11
Stage 13 x 11
"Moscow"



12
Truss applications
Technical data



14
Event System EV 86
Stages + stands



16
Event System EV 100
Stages + stands



18
Event System EV 104
Stages + stands



20
Podium system
PO 64



21
Stand system
TR 79



22
Event special
designs



24
Product line
FOH tower



26
Product line
Camera towers



27
Product line Stage
Direction Towers



28
Product line
PA wings/attachments



30
Product line
Stairway systems

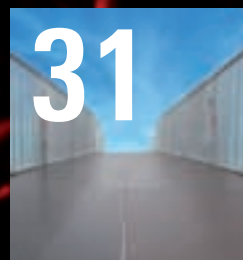

31
Product line
Ramps

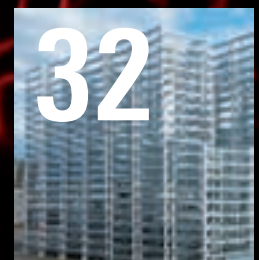

32
Accessories for
Event scaffolding
construction

Layher Truss Systems

Lightweight, versatile and strong.

6



Layher Event Stage 7 x 4 "Verona"

7

So that even small festivals will make a big impression.

The 23 m² Event stage "Verona" is as impressive as it is attractive. The interaction of Layher Truss System 29/4 for the roof structure with the Layher Event Systems EV 86, EV 100 or EV 104 for the stage structure enables you to put on a magnificent and safe appearance.



Including roof and wall sheets



Stage system based on Layher Allround equipment!

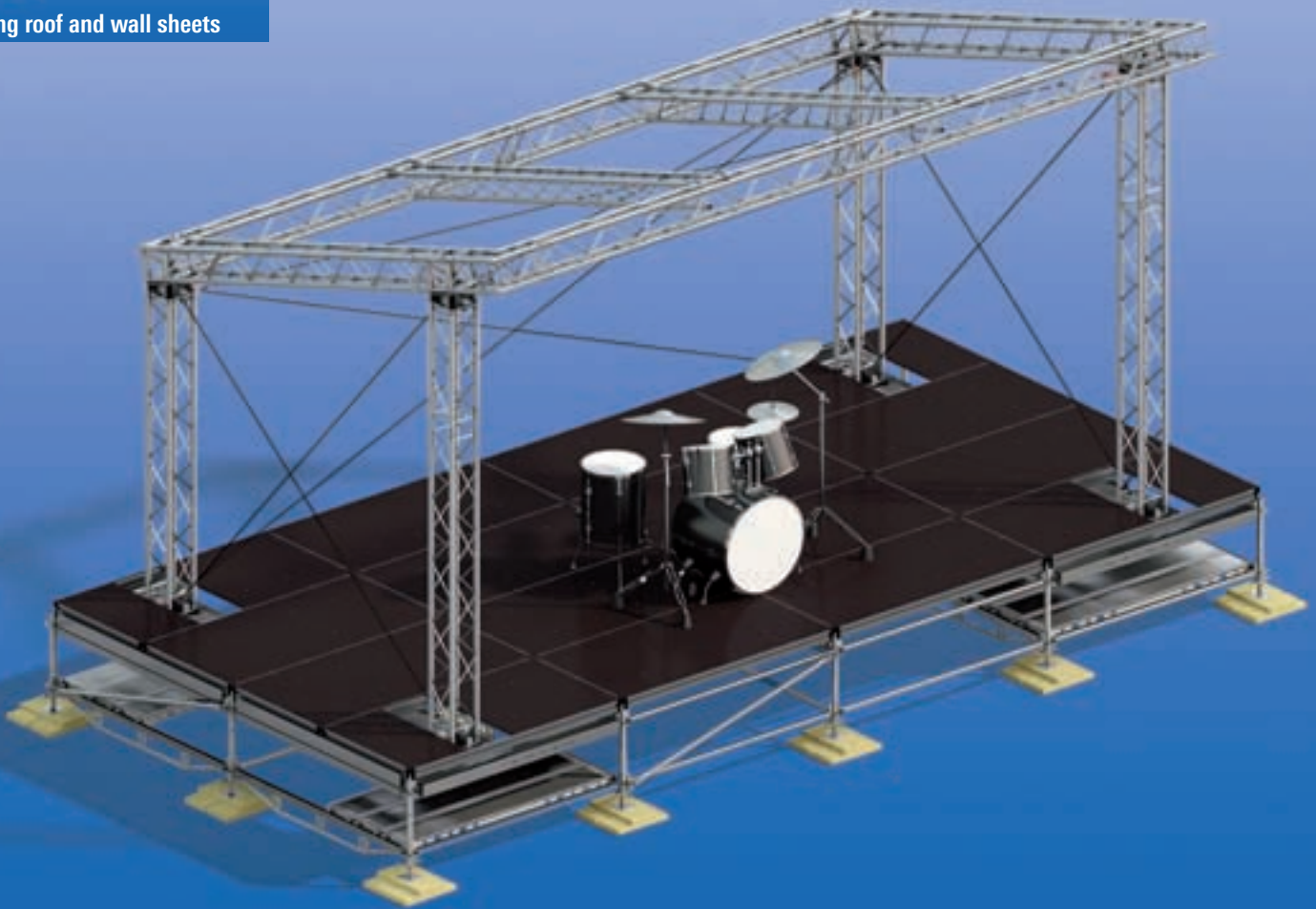

"Verona" Complete KITS

KIT 5018601 Event stage "Verona" 7 x 4 in System EV 86

KIT 5010001 Event stage "Verona" 7 x 4 in System EV 100

KIT 5010401 Event stage "Verona" 7 x 4 in System EV 104

A complete inspection book is available for all variants from 7 x 4 to 13 x 11!

Basic technical data

Stage size EV 86: 8.44 x 5.29 m
Stage size EV 100: 8.15 x 4.15 m
Stage size EV 104: 8.44 x 4.29 m

Permissible stage load capacity: 500 kg/m²
Total height: 4.75 m
Roofed area: 7.10 x 3.78 m
Clear height: 3.55 m (front)
Max. roof load: 470 kg

System tower: 29/4
System main beam: 29/4

Maximum wind speeds
in operation: 72 km/h
not in operation*: 128 km/h

* without wall sheets

All dimensions specified are external dimensions.

Layher Event Stage 9x6 "Madrid"

Economic efficiency in its finest form.

8

With more than 52 m² of roof-covered stage area, this stage is an extremely attractive and economical variant – in both its purchase and its assembly. What's more, the stage roof is persuasive thanks to its outstanding load-bearing values.



Stage system based on Layher Allround equipment!

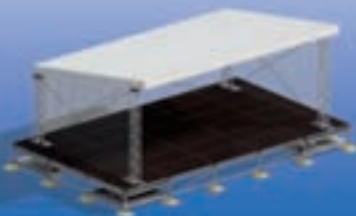

Including roof and wall sheets

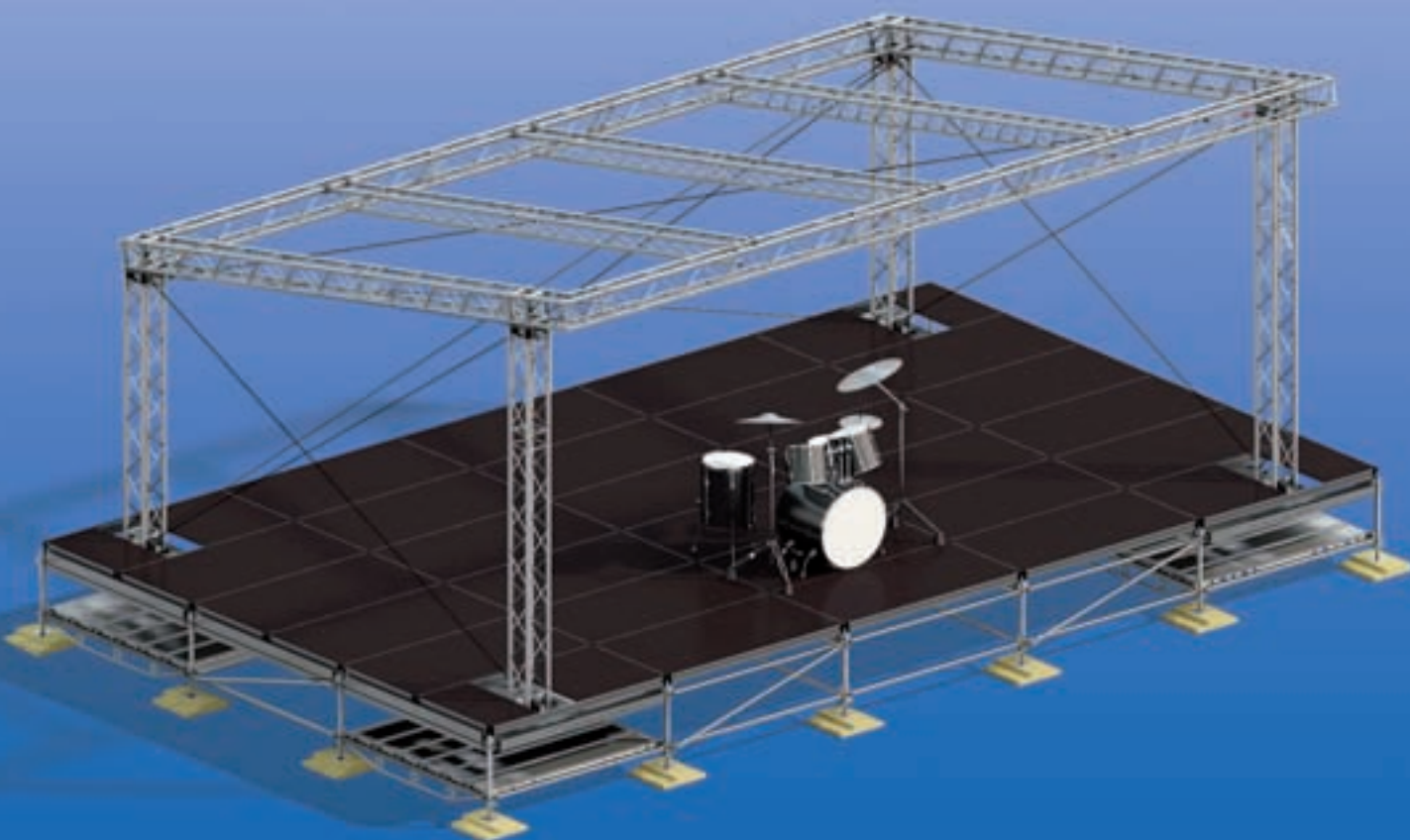

"Madrid" Complete KITS

KIT 5018602 Event stage "Madrid" 9 x 6 in System EV 86

KIT 5010002 Event stage "Madrid" 9 x 6 in System EV 100

KIT 5010402 Event stage "Madrid" 9 x 6 in System EV 104

A complete inspection book is available for all variants from 7 x 4 to 13 x 11!

Basic technical data

Stage size EV 86:	10.51 x 6.15 m	System tower:	29/4
Stage size EV 100:	10.15 x 6.15 m	System main beam:	29/4
Stage size EV 104:	10.51 x 6.37 m		
Permissible stage load capacity:	500 kg/m ²	Maximum wind speeds	
Total height:	4.75 m	in operation:	72 km/h
Roofed area:	9.10 x 5.75 m	not in operation* :	128 km/h
Clear height:	3.55 m (front)		
Max. roof load:	720 kg		

* without wall sheets

All dimensions specified are external dimensions.

Layher Event Stage 11 x 7 "Sydney"

Strength meets elegance.

9

With more than 80 m² of roof-covered stage area, this is a particularly elegant and very strong variant. For all variants up to a roof size of 13 x 11 m², an inspection book is included. That means you can use the flexibility of this system profitably for further projects.

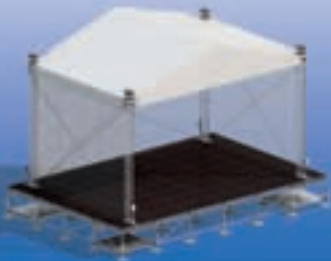

Including roof and wall sheets



Stage system based on Layher Allround equipment!

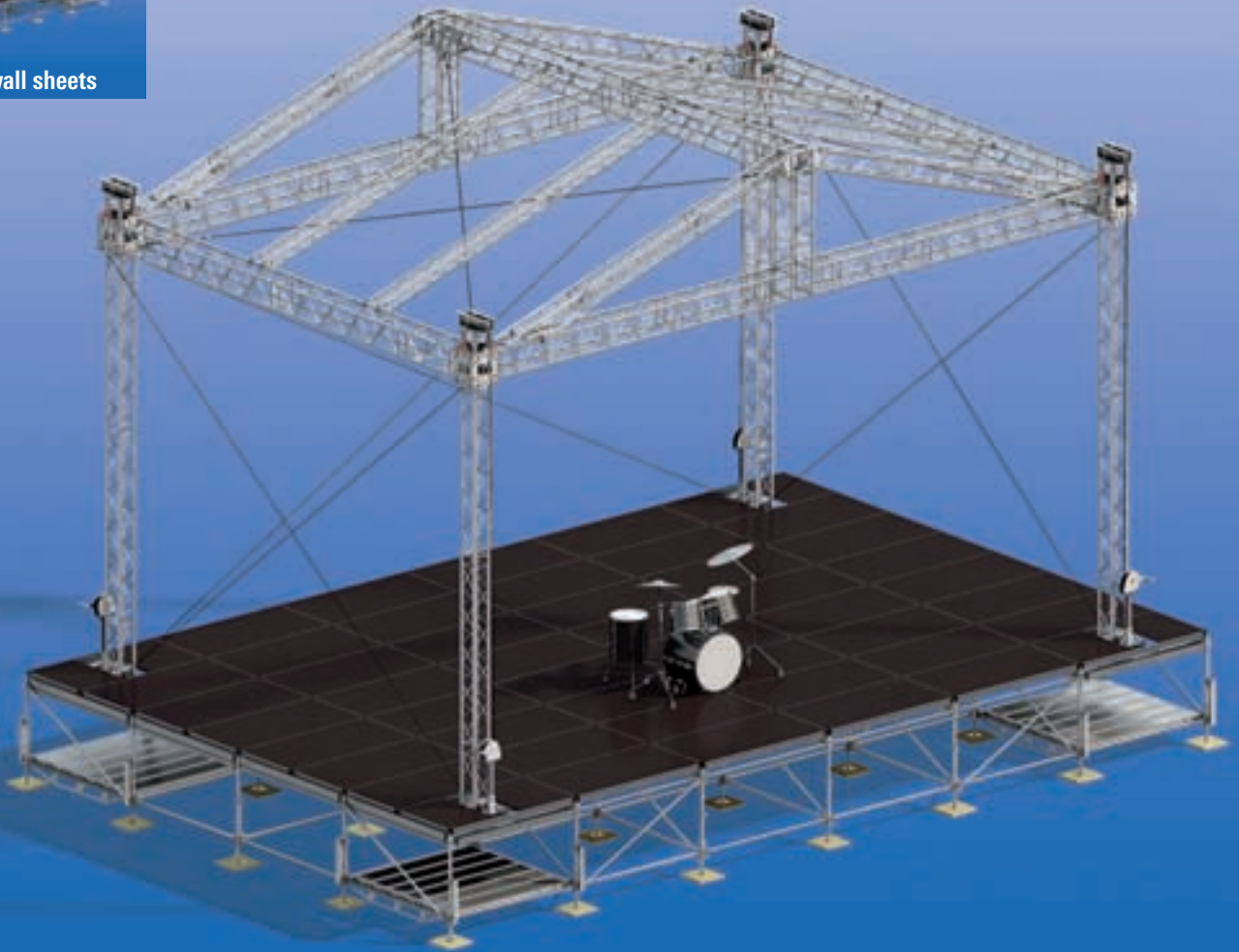

"Sydney" Complete KITS

KIT 5028601 Event stage "Sydney" 11 x 7 in System EV 86

KIT 5020001 Event stage "Sydney" 11 x 7 in System EV 100

KIT 5020401 Event stage "Sydney" 11 x 7 in System EV 104

A complete inspection book is available for all variants from 7 x 4 to 13 x 11!!

Basic technical data

Stage size EV 86: 12.58 x 7.87 m
Stage size EV 100: 12.15 x 8.15 m
Stage size EV 104: 12.58 x 8.44 m

Permissible stage load capacity: 500 kg/m²
Total height: 8.81 m
Roofed area: 10.98 x 7.33 m
Clear height: 5.89 m
Max. roof load: 1.680 kg

System tower: 29/4
System main beam: 39/4

Maximum wind speeds
in operation: 72 km/h
not in operation*: 128 km/h

* without wall sheets

All dimensions specified are external dimensions.

Layher Event Stage 11 x 9 "London"

10

Your entry into the "100 Class".

This stage is your entry ticket to the category of truss-type stages with more than 100 m² of roofed stage area. It has both excellent load-bearing capacities and an overall low transport and storage volume.

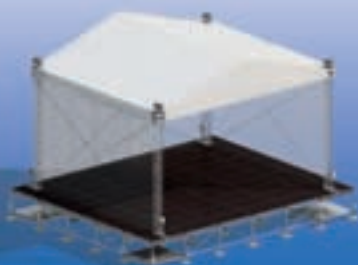

Including roof and wall sheets



Stage system based on Layher Allround equipment!

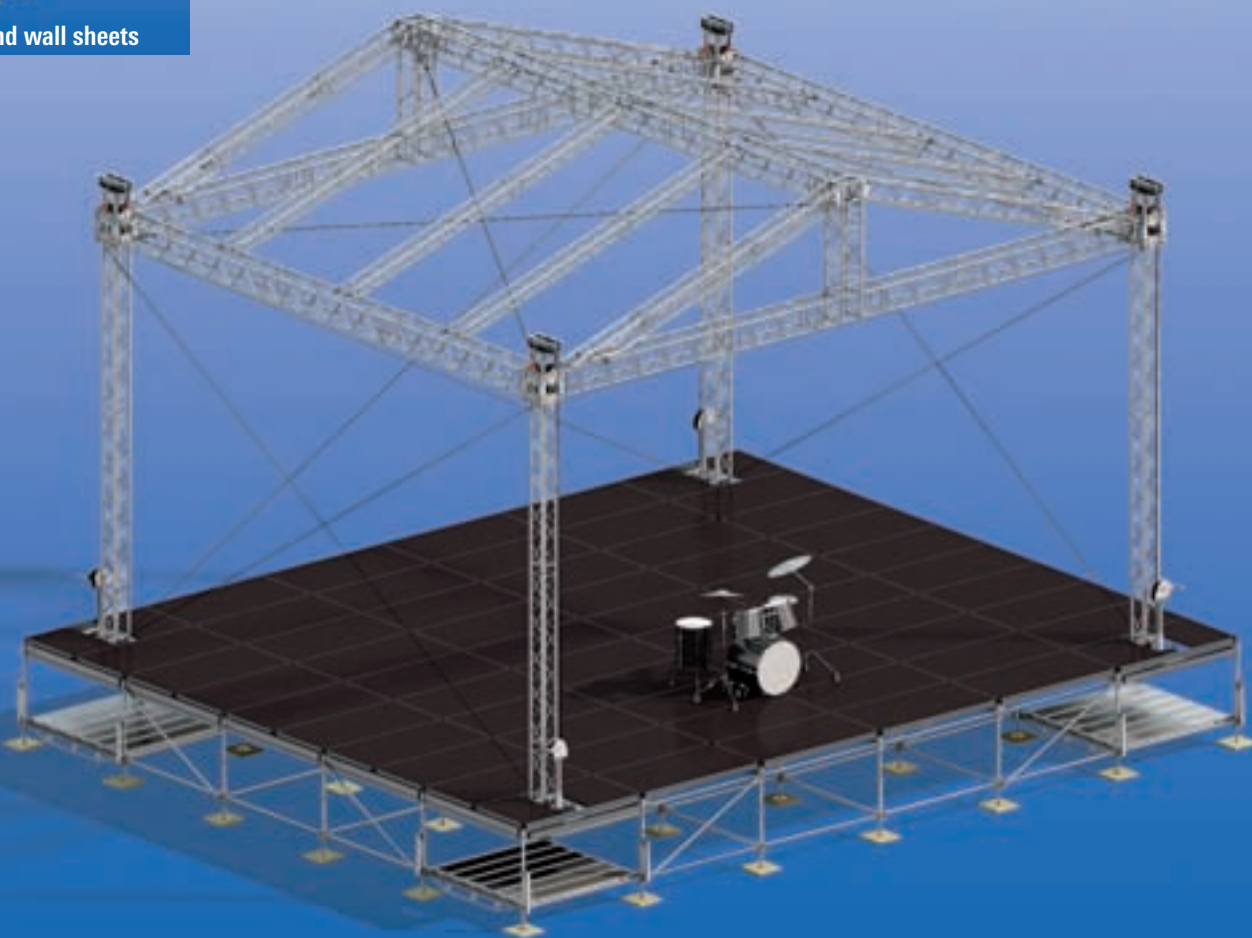

"London" Complete KITS

KIT 5028602 Event stage "London" 11 x 9 in System EV 86

KIT 5020002 Event stage "London" 11 x 9 in System EV 100

KIT 5020402 Event stage "London" 11 x 9 in System EV 104

A complete inspection book is available for all variants from 7 x 4 to 13 x 11!

Basic technical data

Stage size EV 86:	12.58 x 9.58 m	System tower:	29/4
Stage size EV 100:	12.15 x 10.15 m	System main beam:	39/4
Stage size EV 104:	12.58 x 10.51 m		
Permissible stage load capacity:	500 kg/m ²	Maximum wind speeds	
Total height:	8.81 m	in operation:	72 km/h
Roofed area:	10.98 x 9.33 m	not in operation*:	128 km/h
Clear height:	5.89 m		
Max. roof load:	2.040 kg		

* without wall sheets

All dimensions specified are external dimensions.

Layher Event Stage 13 x 11 "Moscow"

11

Simply beautiful and beautifully simple.

Nearly 150 m² of roof-covered stage area creates space for extra-special events. What's more, the design provides you with particularly high load capacities while keeping the transport volume within limits.



Including roof and wall sheets



Stage system based on Layher Allround equipment!

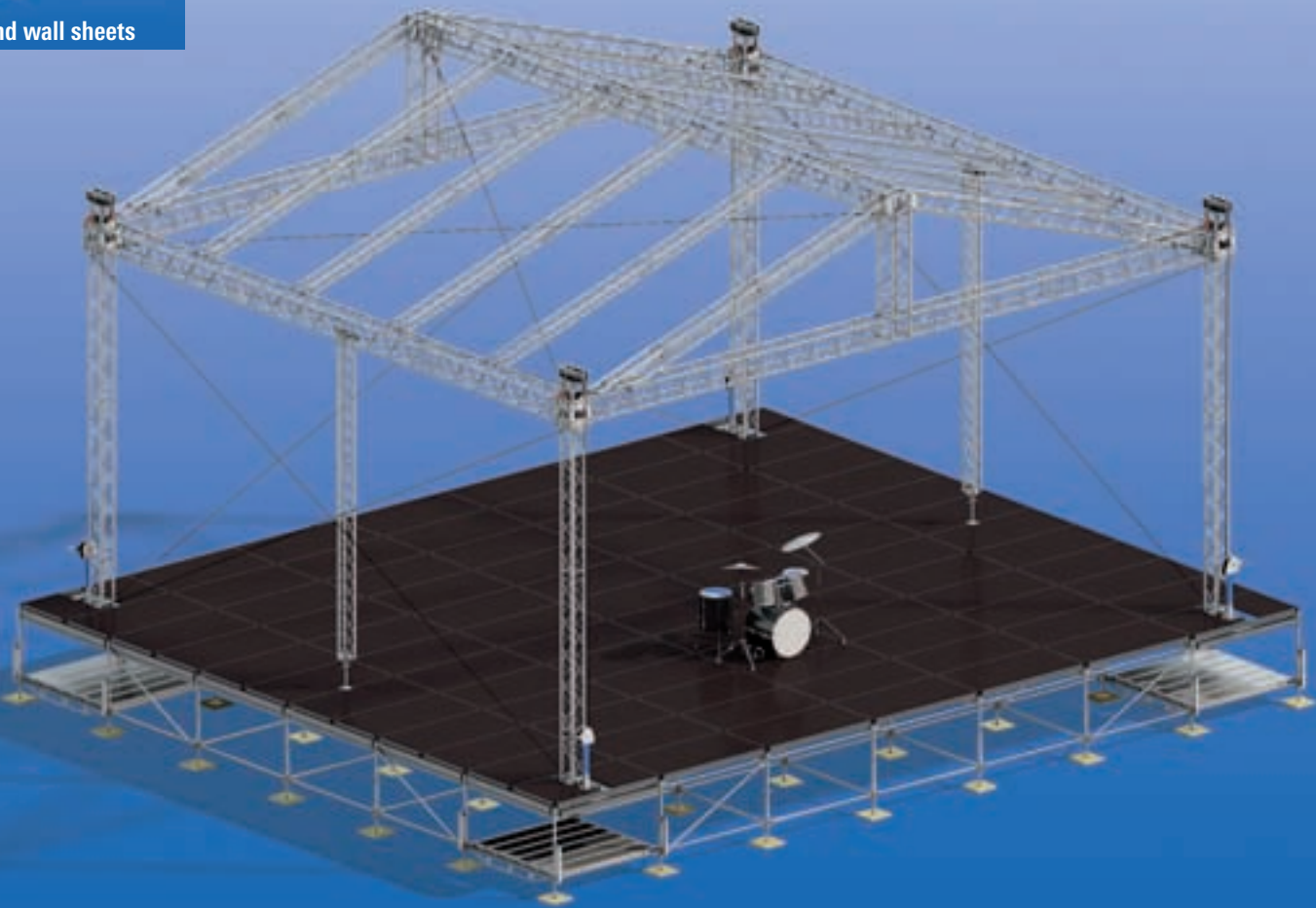

"Moscow" Complete KITS

KIT 5028603 Event stage "Moscow" 13 x 11 in System EV 86

KIT 5020003 Event stage "Moscow" 13 x 11 in System EV 100

KIT 5020403 Event stage "Moscow" 13 x 11 in System EV 104

A complete inspection book is available for all variants from 7 x 4 to 13 x 11!

Basic technical data

Stage size EV 86: 14.65 x 12.15 m
Stage size EV 100: 14.15 x 12.15 m
Stage size EV 104: 14.65 x 12.58 m

Permissible stage load capacity: 500 kg/m²
Total height: 9.11 m
Roofed area: 12.98 x 11.33 m
Clear height: 5.89 m
Max. roof load: 2.690 kg

System tower: 29/4
System main beam: 39/4

Maximum wind speeds
in operation: 72 km/h
not in operation*: 128 km/h

* without wall sheets

All dimensions specified are external dimensions.

Layher Truss Systems

Extremely versatile in use.

12



Trade fair and presentation stands



Cable bridges

The Layher Truss Systems can be used not only for stage roofs but for many other applications, too. Trade fair construction with trade fair or presentation stands is a central field for use of the high-performance Layher Truss System. In the case of vehicle presentations, this system is being used more and more frequently. Thanks to the impressive load-bearing capacities, you can keep on building with Layher when other systems have had to give up.



Advertising tower

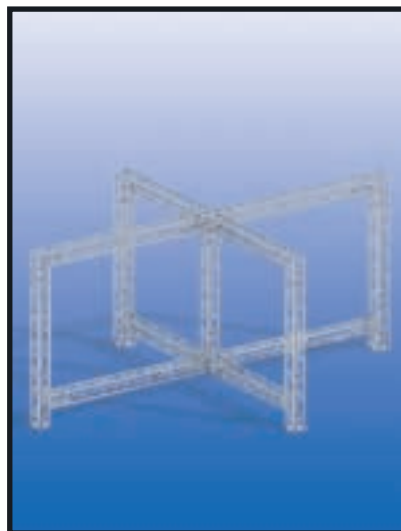

Advertising boards

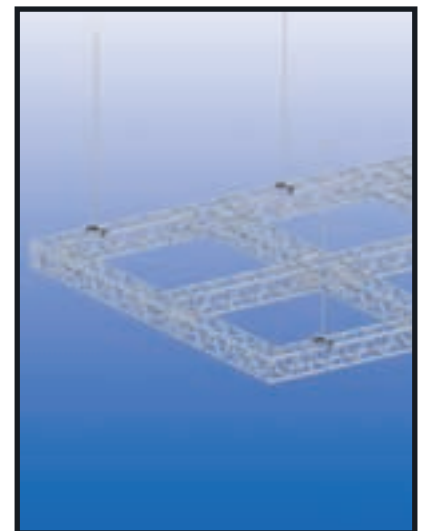

Rigging

Put yourself and your advertising message in the right light! With the Layher Truss System you can put up large advertising banners and also fit the lighting on this effective structure. This system is ideal as a mobile and attractive room divider in salesrooms and open-plan offices. It's great to use a system that puts practically no limits on your imagination – the Layher Truss Systems.

Layher Truss Systems

Basic components and technical systems.

13

Truss
System 29/4
System 39/4



2-way corner 45°
System 29/4: A = 1000 mm
System 39/4: A = 1200 mm

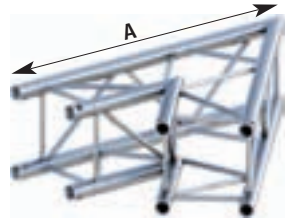

2-way corner 60°
System 29/4: A = 800 mm
System 39/4: A = 1200 mm

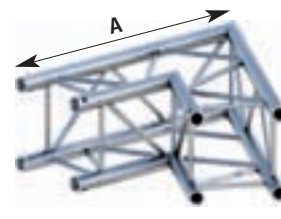

2-way corner 90°
System 29/4: A = 500 mm
System 39/4: A = 600 mm

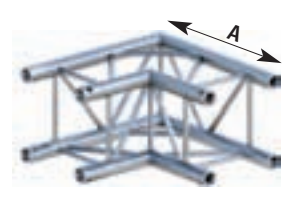

2-way corner 120°
System 29/4: A = 500 mm
System 39/4: A = 600 mm

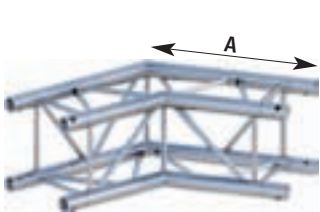

2-way corner 135°
System 29/4: A = 500 mm
System 39/4: A = 600 mm

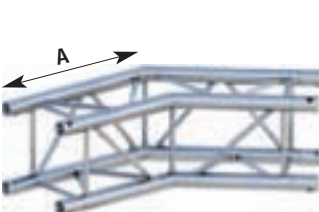

3-way corner 90°
System 29/4: A = 500 mm
System 39/4: A = 600 mm

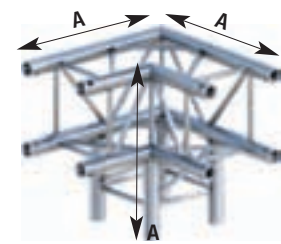

3-way T-piece
System 29/4: A = 710 B = 500 mm
System 39/4: A = 810 B = 600 mm

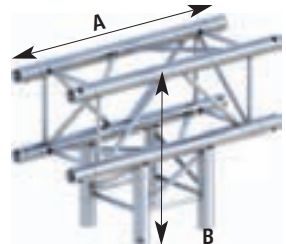

4-way T-piece
System 29/4: A = 710 B = 500 mm
System 39/4: A = 810 B = 600 mm

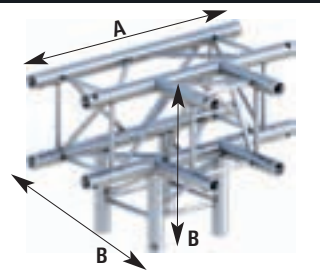

4-way cross
System 29/4: A = 710 mm
System 39/4: A = 810 mm

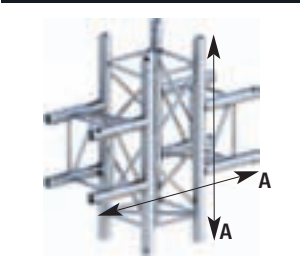

5-way cross
System 29/4: A = 710 B = 500 mm
System 39/4: A = 810 B = 600 mm

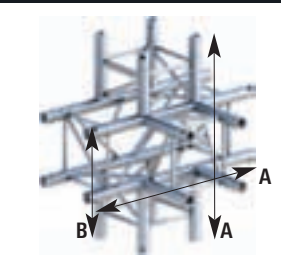

Corner Block
System 29/4
System 39/4



System 29/4

System 39/4

	Spans (m)	Point load (kg) in centre of bay	Degree of sag (mm)	2 point loads (kg) in the 1/3 points	Degree of sag (mm)	Line load (kg/m)	Degree of sag (mm)
System 29/4	4.0	1464.0	11.0	849.0	11.0	425.0	8.0
	6.0	964.0	25.0	723.0	32.0	281.0	27.0
	8.0	710.0	45.0	532.0	57.0	177.0	56.0
	10.0	555.0	71.0	416.0	89.0	111.0	87.0
	12.0	449.0	102.0	337.0	128.0	75.0	125.0
	14.0	371.0	140.0	278.0	147.0	53.0	170.0
	16.0	311.0	185.0	233.0	224.0	39.0	222.0
System 39/4	4.0	2078.0	8.0	1219.0	8.0	610.0	6.0
	6.0	1372.0	18.0	1029.0	23.0	404.0	20.0
	8.0	1014.0	32.0	761.0	41.0	254.0	40.0
	10.0	797.0	50.0	597.0	63.0	159.0	62.0
	12.0	649.0	72.0	486.0	91.0	108.0	89.0
	14.0	541.0	99.0	405.0	124.0	77.0	121.0
	16.0	458.0	131.0	343.0	162.0	57.0	158.0
	18.0	391.0	167.0	293.0	204.0	43.0	200.0

Layher Event System EV 86

The universal stage system.

14

The Event System EV 86 offers you a wide range of possibilities for building podiums and stages – to carry loads of 5.0 or 7.5 kN/m² and with deck lengths of 2.07 m or 2.57 m. This provides you with particular flexibility for reacting to every requirement.



Event system based on Layher Allround equipment!



“Event System EV 86” Complete KITS

System EV 86 stage / podium

KIT 5048601	43 m ²	8.28	x	5.14 m	Height 0.80 m
KIT 5048602	80 m ²	10.35	x	7.71 m	Height 0.80 m
KIT 5048603	128 m ²	12.42	x	10.28 m	Height 0.80 m
KIT 5048604	186 m ²	14.49	x	12.85 m	Height 0.80 m
KIT 5048605	43 m ²	8.28	x	5.14 m	Height 1.30 m
KIT 5048606	80 m ²	10.35	x	7.71 m	Height 1.30 m
KIT 5048607	128 m ²	12.42	x	10.28 m	Height 1.30 m
KIT 5048608	186 m ²	14.49	x	12.85 m	Height 1.30 m

System EV 86Q stage / podium

KIT 5048617	40 m ²	7.71	x	5.14 m	Height 0.80 m
KIT 5048618	80 m ²	10.28	x	7.71 m	Height 0.80 m
KIT 5048619	132 m ²	12.85	x	10.28 m	Height 0.80 m
KIT 5048620	198 m ²	15.42	x	12.85 m	Height 0.80 m
KIT 5048621	40 m ²	7.71	x	5.14 m	Height 1.30 m
KIT 5048622	80 m ²	10.28	x	7.71 m	Height 1.30 m
KIT 5048623	132 m ²	12.85	x	10.28 m	Height 1.30 m
KIT 5048624	198 m ²	15.42	x	12.85 m	Height 1.30 m

Inspection books are available for the Event System EV 86!



For every surface

- ▶ A key advantage of all stages based on the Layher Event System is the possibility of optimally compensating for irregularities and sloping ground with maximum precision and stability. Every artiste will have a sure footing on the non-slip stage surfaces.

Universal applicability

- ▶ The Layher Event systems have a wide range of uses, for example in fashion shows, since the substructure of Layher Allround equipment is particularly low in vibration when compared with conventional insert-leg systems.

Versatile roof covering for stages

- ▶ With the Layher construction kit, you have a range of possibilities for creating a stage roof system. You can choose here from the truss, keder roof, lightweight cassette roof systems, or the particularly strong cassette roof.

Layher Event System EV 86

Effective for stand construction.

15

This system is outstandingly suitable for stands with benches, shell seats or folding seats. The low floor width allows you to provide a large number of seats on a relatively small surface area. For outdoor events, the versatile steel decks can be used.

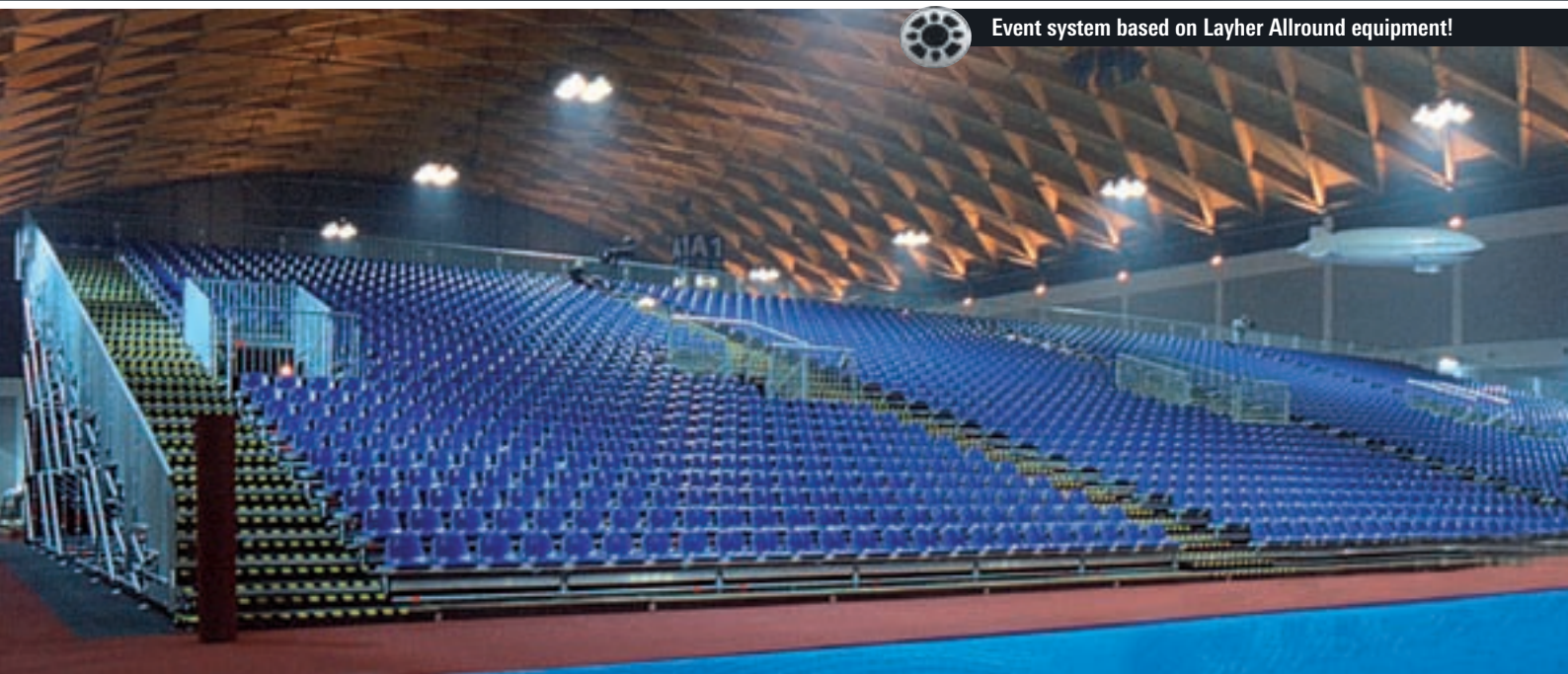

Event system based on Layher Allround equipment!

Outdoor use in stadiums

- ▶ In many sports grounds, for example in the Feyenoord Rotterdam stadium, stands made by Layher are in use. These systems are distinguished by their particularly high degree of flexibility and comprehensive extension options. Ramps for wheelchair users can also be integrated without problem into the structure.

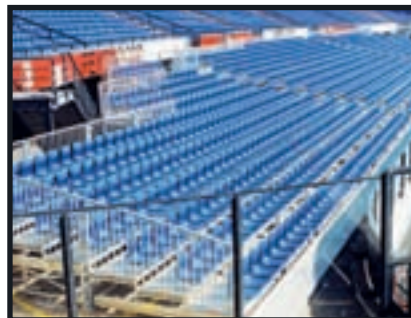

Stand roofs

- ▶ There is a choice of numerous systems for roofing of stands, for example the keder roof system used for the annual degree award ceremonies at the University of Bonn.
- ▶ You also have a choice with the design of the bucket seats – thanks to numerous RAL colours, customer-specific solutions are possible without any problem.



One system – 3 rises

- ▶ For individual requirements, Layher offers you not only the standard rise of 166 mm, but also 250 mm and 333 mm rises.
- ▶ Different rises can be combined in one stand: this creates the so-called arena effect.



“Event System EV 86” Complete KITS

Already calculated KITS are available for the following stand sizes – please send your enquiry:

Number of seat rows:	4 – 31
Number of seats / row:	8 – 104
Number of seats in all:	32 – 3224

Inspection books are available for the Event System EV 86!

Basic technical data EV 86

EV 86:	Deck size:	2.07 x 0.86 m
	Deck weight:	24 kg
	Standard dimensions:	2.07 x 2.57 m
	Load capacity:	5.0 kN/m
EV 86+:	Deck size:	2.07 x 0.86 m
	Deck weight:	24 kg
	Standard dimensions:	2.07 x 2.57 m
	Load capacity:	7.5 kN/m
EV 86Q:	Deck size:	2.57 x 0.86 m
	Deck weight:	32 kg
	Standard dimensions:	2.57 x 2.57 m
	Load capacity:	5.0 kN/m ²

Stand rise Standard:	166 mm
Stand rise Special:	250 + 333 mm

Layher Event System EV 100

The classic system for stage construction.

16

With this system, you can work in a classic dimension for event and trade fair structures. Layher offers you the same parts with the variety and flexibility that has been a consistent feature of systems in Layher dimensions for years now. This applies particularly for the Layher Allround substructure of the stage or stand.



Event system based on Layher Allround equipment!

“Event System EV 100” Complete KITS

System EV 100 – stage / podium

KIT 5040001	24 m ²	6.00 x 4.00 m	Height 0.80 m
KIT 5040002	48 m ²	8.00 x 6.00 m	Height 0.80 m
KIT 5040003	60 m ²	10.00 x 6.00 m	Height 0.80 m
KIT 5040004	80 m ²	10.00 x 8.00 m	Height 0.80 m
KIT 5040005	96 m ²	12.00 x 8.00 m	Height 0.80 m
KIT 5040006	120 m ²	12.00 x 10.00 m	Height 0.80 m
KIT 5040007	140 m ²	14.00 x 10.00 m	Height 0.80 m
KIT 5040008	168 m ²	14.00 x 12.00 m	Height 0.80 m
KIT 5040009	192 m ²	16.00 x 12.00 m	Height 0.80 m
KIT 5040010	224 m ²	16.00 x 14.00 m	Height 0.80 m
KIT 5040011	24 m ²	6.00 x 4.00 m	Height 1.30 m
KIT 5040012	48 m ²	8.00 x 6.00 m	Height 1.30 m
KIT 5040013	60 m ²	10.00 x 6.00 m	Height 1.30 m
KIT 5040014	80 m ²	10.00 x 8.00 m	Height 1.30 m
KIT 5040015	96 m ²	12.00 x 8.00 m	Height 1.30 m
KIT 5040016	120 m ²	12.00 x 10.00 m	Height 1.30 m
KIT 5040017	140 m ²	14.00 x 10.00 m	Height 1.30 m
KIT 5040018	168 m ²	14.00 x 12.00 m	Height 1.30 m
KIT 5040019	192 m ²	16.00 x 12.00 m	Height 1.30 m
KIT 5040020	224 m ²	16.00 x 14.00 m	Height 1.30 m

Other sizes and dimensions are of course also possible on request!

Inspection books are available for the Event System EV 100!



Flexible forms

- ▶ The potential for expansion of the Event Systems is as wide-ranging as the events themselves. Thanks to the plastic corners, designed to be removable, on every Event deck, you can pass through the standards out of the substructure without any problems and in so doing create almost any stage form.

Guard rails for stages

- ▶ Layher offers you a host of possibilities for fitting guard rails to your stages. In this way – as can be seen on the photo – offset handrails are available as well as guard rails with child safety feature. Conventional Allround ledgers can also be used.

Roofs for stages

- ▶ In addition to roofs using the Layher truss system, you can also – depending on the application – use the keder roof, lightweight cassette roof and cassette roof systems. Detailed information on these can be found in separate catalogues and price lists.

Layher Event System EV 100

17

The all-rounder in stand construction.

This system is the all-rounder among stand systems. The deck width of 1.00 m provides you with an absolutely free hand when it comes to designing the seats, and chairs too can be accommodated without difficulty on these platforms.



Event system based on Layher Allround equipment!

For all ground forms

- ▶ The Layher Allround substructure makes it possible: stands using the Event System fit on practically any ground and can be adapted to nearly every ground plan without having to compromise on structural stability and safety.



Seats for every event

- ▶ With the Layher Event System EV 100, you have every option open to you when selecting the seat variants: the deck is wide enough for putting up chairs, and you can also use benches, shell seats or folding seats with ease, and give your guests plenty of leg room.



Different rise variants

- ▶ The standard rise is 250 mm and ensures a perfectly clear field of vision for practically all events. Depending on the application, rises of 375 mm (see photo, Tokyo Marathon 2007) and 500 mm can be used too.

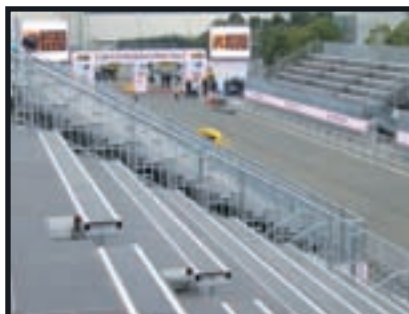

“Event System EV 100” Complete KITS

Already calculated KITS are available for the following stand sizes – please send your enquiry:

Number of seat rows:	2 – 21
Number of seats / row:	8 – 104
Number of seats in all:	16 – 2184

Inspection books are available for the Event-system EV 100!

Basic technical data EV 100

EV 100: Deck size:	2.00 x 1.00 m
Deck weight:	28.0 kg
Standard dimensions:	2.00 x 2.00 m
Permissible load capacity:	7.5 kN/m ²

Stand rise Standard:	250 mm
Stand rise Special:	375 + 500 mm

Layher Event System EV 104

The simple yet ingenious stage.

18

One of the most popular systems in stage construction. Simple because the substructure using Layher Allround equipment uses only one ledger and diagonal brace length. Ingenious because it's based on the Layher system dimension, available worldwide, and hence ensures a unique material availability around the globe.



Event system based on Layher Allround equipment!

"Event System EV 104" Complete KITS

System EV 104 – stage / podium

KIT 5040401	26 m ²	6.21 x 4.14 m	Height 0.80 m
KIT 5040402	52 m ²	8.28 x 6.21 m	Height 0.80 m
KIT 5040403	65 m ²	10.35 x 6.21 m	Height 0.80 m
KIT 5040404	86 m ²	10.35 x 8.28 m	Height 0.80 m
KIT 5040405	103 m ²	12.42 x 8.28 m	Height 0.80 m
KIT 5040406	129 m ²	12.42 x 10.35 m	Height 0.80 m
KIT 5040407	150 m ²	14.49 x 10.35 m	Height 0.80 m
KIT 5040408	180 m ²	14.49 x 12.42 m	Height 0.80 m
KIT 5040409	206 m ²	16.56 x 12.42 m	Height 0.80 m
KIT 5040410	240 m ²	16.56 x 14.49 m	Height 0.80 m
KIT 5040411	26 m ²	6.21 x 4.14 m	Height 1.30 m
KIT 5040412	52 m ²	8.28 x 6.21 m	Height 1.30 m
KIT 5040413	65 m ²	10.35 x 6.21 m	Height 1.30 m
KIT 5040414	86 m ²	10.35 x 8.28 m	Height 1.30 m
KIT 5040415	103 m ²	12.42 x 8.28 m	Height 1.30 m
KIT 5040416	129 m ²	12.42 x 10.35 m	Height 1.30 m
KIT 5040417	150 m ²	14.49 x 10.35 m	Height 1.30 m
KIT 5040418	180 m ²	14.49 x 12.42 m	Height 1.30 m
KIT 5040419	206 m ²	16.56 x 12.42 m	Height 1.30 m
KIT 5040420	240 m ²	16.56 x 14.49 m	Height 1.30 m

Other sizes and dimensions are of course also possible on request!

Inspection books are available for the Event System EV 104!



Stage EV 104 with cassette roof

- ▶ This stage was created in combination with the Layher cassette roof system at the 750th anniversary celebrations in Kaliningrad. The lateral attachments made using Allround equipment double as PA wings and holders for the roof.



Stage EV 104 with keder roof

- ▶ Concert stage with keder roof. Built in 2006 in Spain for the famous b-estival. Layher also offers the combination of stage and keder roof in an inspection book for a total of 10 assembly variants.



Wide range of possible uses

- ▶ With the Layher Event System, you can earn money even when there are no musical or sporting events on the agenda, for example for beer gardens, terraces, observation platforms, presentation platforms and much more besides. The only limits here are your own imagination.

Layher Event System EV 104

The comfortable stand for all events.

19

Stands made using the Layher Event System EV 104 are the most comfortable variant. Assembly is extremely easy and safe thanks to the square basic configuration, and the amply sized platforms do not impose any limits when it comes to designing the seating.



Event system based on Layher Allround equipment!



A construction kit for every case

- ▶ This project impressively shows the technical versatility of the Layher Event System. Pedestrian and cycle paths have to be built over, VIP and gastronomy areas need a safe and high-quality setting, and rest areas must ensure sufficient space for relaxing.

Maximum comfort

- ▶ This is where the Event System EV 104 shows its real forte: maximum sitting comfort even when already existing chairs – as can be seen on the photo of the Freiburg trade fair – utilising. With the standard rise of 250 mm, the best view is also assured for all the audience.

Versatility in the rises

- ▶ The standard rise of 250 mm assures for practically all events an excellent field of vision. Depending on the application, rises of 375 mm or 500 mm (see right photo) can also be provided.



“Event System EV 104” Complete KITS

Already calculated KITS are available for the following stand sizes – please send your enquiry:

Number of seat rows:	2 – 21
Number of seats / row:	8 – 104
Number of seats in all:	16 – 2184

Inspection books are available for the Event System EV 104!

Basic technical data EV 104

EV 104: Deck size:	2.07 x 1.04 m
Deck weight:	30.0 kg
Standard dimensions:	2.07 x 2.07 m
Permissible load capacity:	7.5 kN/m ²

Stand rise Standard:	250 mm
Stand rise Special:	375 + 500 mm

Layher Podium System PO 64

The tried and tested system for all stages.

20

For more than 20 years now, the podium system PO 64 has been in use worldwide whenever podiums have had to be built quickly and above all inexpensively. The main advantage of this system is the minimal number of components needed to build a stage.

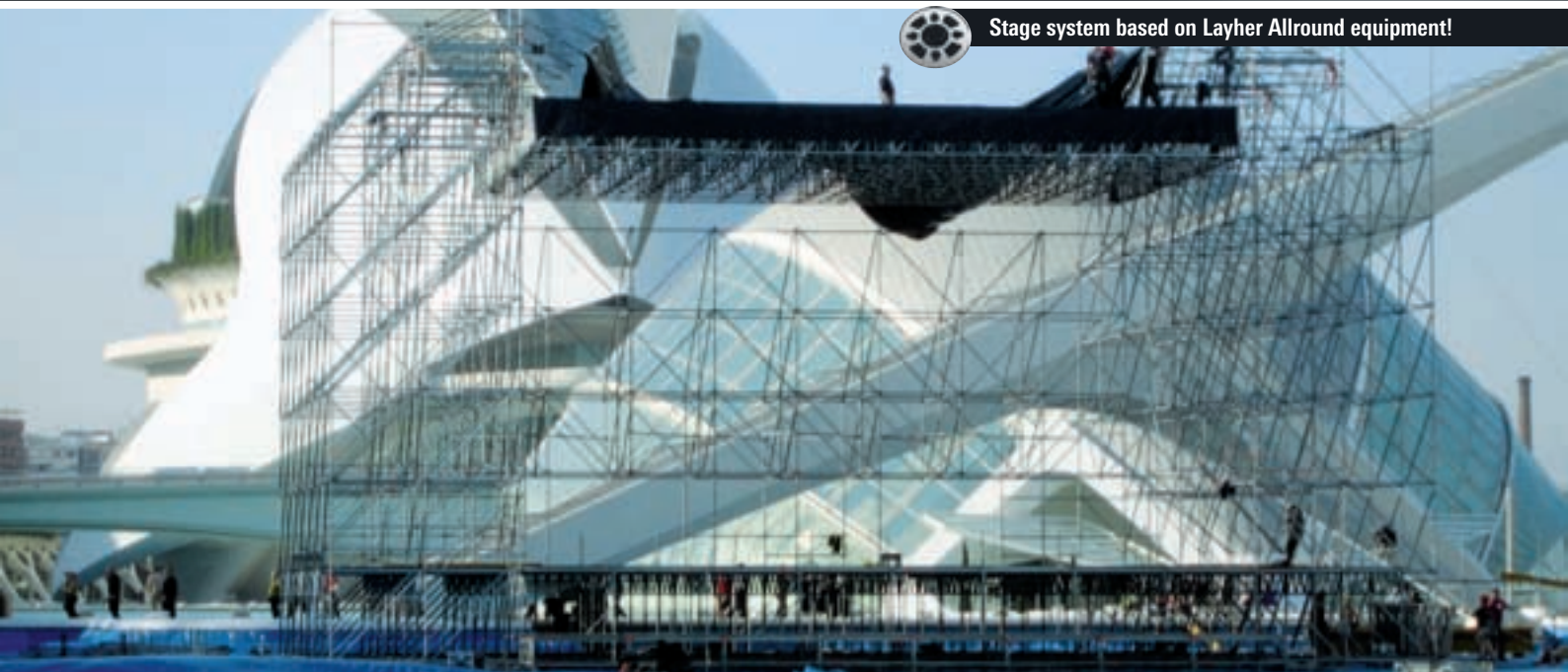

Stage system based on Layher Allround equipment!

“Event System PO 64” Complete KITS

KIT 5056401	43 m ²	8.28 x 5.14 m	Height 0.80 m
KIT 5056402	80 m ²	10.35 x 7.71 m	Height 0.80 m
KIT 5056403	128 m ²	12.42 x 10.28 m	Height 0.80 m
KIT 5056404	186 m ²	14.49 x 12.85 m	Height 0.80 m
KIT 5056405	255 m ²	16.56 x 15.42 m	Height 0.80 m

KIT 5056406	43 m ²	8.28 x 5.14 m	Height 1.30 m
KIT 5056407	80 m ²	10.35 x 7.71 m	Height 1.30 m
KIT 5056408	128 m ²	12.42 x 10.28 m	Height 1.30 m
KIT 5056409	186 m ²	14.49 x 12.85 m	Height 1.30 m
KIT 5056410	255 m ²	16.56 x 15.42 m	Height 1.30 m

Other sizes and dimensions are of course also possible on request!

Inspection books are available for the Event System PO 64!

Basic technical data PO 64

PO 64:	Deck size:	2.07 x 0.64 m
	Deck weight:	24.5 kg
	Standard dimensions:	2.07 x 2.57 m
	Permissible load capacity:	7.5 kN/m ²

Design with recesses on the sides or ends, or without projections.



For major events ...

- ▶ Thanks to Layher Allround substructure, usable for all stage and podium sizes. The fact that the decks are bolted to the supporting elements ensures a sturdy and gap-free podium surface.

... and minor parties

- ▶ The podium system PO 64 is ideal for building small stages, for example for city festivals. Small-scale roofs can be attached to the substructure.

Matching the Layher construction kit

- ▶ With the comprehensive Layher construction kit, roofs, stairways or ramps can be easily connected up to the PO 64 system. The very flat design of the PO decks ensures that there are no raised edges to trip over when Layher stairway systems are connected.

Layher Stand System TR 79

Popular and modern even after 20 years.

21

For flexible and inexpensive building of a wide range of stands. Different rises, angle elements for radii and expansion parts for no-seat stands are characteristic for its variability. So the system remains as modern and economical as ever, even after more than 20 years in use.



Stand system based on Layher Allround equipment!



Maximum flexibility

- ▶ Adaptable: Use in extremely confined spaces around the bull ring plaza in Spain.
- ▶ Clear view: Thanks to the use of different rise dimensions, all visitors have an unimpeded view of what's going on.
- ▶ Safe: Integration of the accesses into the stand ensures safe access.

Stands for every event

- ▶ This stand was built in beautiful surroundings in the heart of Madrid using the TR 79 system. Equipped with ramps and a platform for wheelchair users, as well as internal stairways, this stand impressively shows the potential of this system.

Very simple assembly

- ▶ With a very small number of different components, this system can be used to build even the biggest stands inexpensively. Steel stringers with permanently welded adapters for benches significantly reduce the assembly costs.



"Event System TR 79" Complete KITS

Already calculated KITS are available for the following stand sizes – please send your enquiry:

Number of seat rows:	2 – 21
Number of seats / row:	8 – 104
Number of seats in all:	16 – 2184

Inspection books are available for the stand system TR 79!

Basic technical data TR 79

TR 79:	Deck size:	2.07 / 2.57 x 0.61 m
	Deck weight 2.07 m:	16.4 kg
	Deck weight 2.57 m:	17.9 kg
	Standard dimensions:	2.07/2.57 x 1.57 m

Permissible load capacity: 7.5 kN/m²

Stand rise Standard:	250 mm
Stand rise Special:	125 + 375 mm

Layher Event Special Designs

When dreams become reality.

22



No-seat stand – Biathlon World Cup 2008 in Ostersund

“Layher only builds seating stands!” – that’s a prejudice which is old history now. For some years now, it has been possible, using the stand system TR 79, to build attractive and modular no-seat stands that offer all the advantages of a typical Layher stand.

Based on Layher Allround equipment, these stands can be adapted to almost any terrain and surface – at a pinch even in water, as has already been done a number of times.

It goes without saying that the legal requirements are met when special stands like this are planned.



Roofed stand – Kaliningrad 2005

At the 750th anniversary celebrations in Kaliningrad, this VIP stand with roof was made using the Layher keder roof system.

It meant that the 400 guests of honour, including the former heads of state Vladimir Putin and Gerhard Schröder, could watch the festivities without worrying about the weather.

The Layher keder roof system is also frequently used as a roof for concert stages. Extremely simple assembly and particularly low weight are the crucial advantages here.



Round stage based on Event Systems

At numerous events it is necessary to cater for special requirements for the stage. Layher offers you not only the classic rectangular ground plans, but also the option of building round or polygonal stages.

The round stage is based on the systems EV 100 or EV 104, and triangular or trapezoidal Event decks can be generally achieved for all Layher Event Systems.

Whatever form is required – Layher can cater to your requirements and make your dreams reality.

Layher Event Special Structures

More possibilities in its finest form.

23



Mobile stage for "DJ BoBo – Pirates of Dance"

In 2005 the highly successful DJ BoBo Tour "Pirates of Dance" was held.

Layher devised a stage in the form of a ship that could be conveyed on rollers block by block. This reduced the assembly time of the stage very much, and the popular Swiss artist and his team were able to give concerts on consecutive days using the same stage.

In 2007 / 2008 too, DJ BoBo successfully toured with "Vampires Alive", once again on Layher stages, across Europe.



Pit Lane Park – BMW Sauber F1 at Valencia 2006

For many years now, BMW have been successfully involved in Formula 1 racing.

To showcase the engineering achievements and the fascinating aspects of Formula 1 racing to the many fans of this Bavarian household name, the Pit Lane Park of BMW Sauber was created away from the racing circuits.

Layher excelled itself here in the supplying the Allround equipment and its Protect System, and helped to give this unique idea a worthy appearance.



Deutsche Post /DHL – DTM Podium DTM 2008

At the German Touring Car Masters, DTM 2008, a VIP podium was designed on behalf of Deutsche Post.

The platform with a permissible load of 500 kg/m² is spanned by a VIP marquee of over 16.5 meters width, offering the visitors a unique view of the pitstop and the race circuit.

Exclusivity – made by Layher.

Layher FOH Tower

The unsung stars at every concert.

24

This new product line, based on the unique Layher Allround equipment, offers you the optimum FOH position for every requirement. Calculated and tested KITS including inspection book are available for all the usual sizes. That means your FOH is splendidly and safely at the centre of attention.



FOH tower based on Layher Allround equipment!

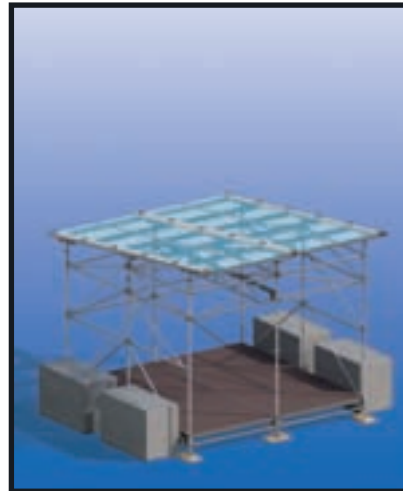

FOH tower 4 x 4 – 1 level

- ▶ Permissible load capacity: lowest level 7.5 kN/m², other levels 2.0 kN/m².
- ▶ Inspection book with structural strength computation according to requirements and standards is available!
- ▶ 3-sided cladding possible and included in strength computation.
- ▶ Ample space in the centre of each level, without standards.

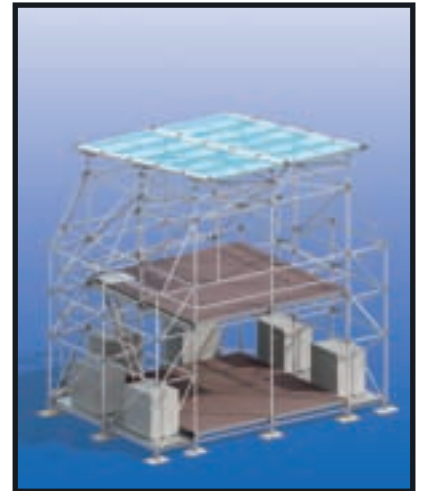

FOH tower 4 x 4 – 2 levels

- ▶ Permissible load capacity: lowest level 7.5 kN/m², other levels 2.0 kN/m².
- ▶ Inspection book with structural strength computation according to requirements and standards is available!
- ▶ 3-sided cladding possible and included in strength computation.
- ▶ Low storey height of 2.50 m thanks to the new Layher FOH beam.

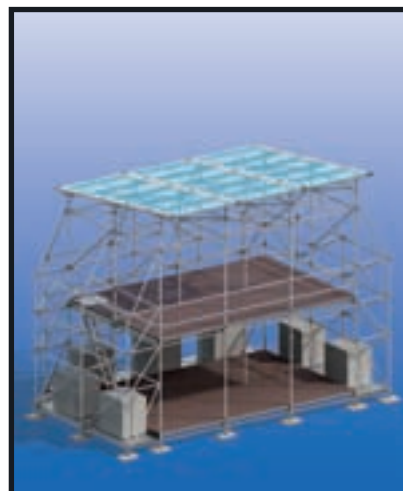

FOH tower 6 x 4 – 2 levels

- ▶ Permissible load capacity: lowest level 7.5 kN/m², other levels 2.0 kN/m².
- ▶ Inspection book with structural strength computation according to requirements and standards is available!
- ▶ 3-sided cladding possible and included in strength computation.
- ▶ Internal access ensures high degree of comfort and safety.

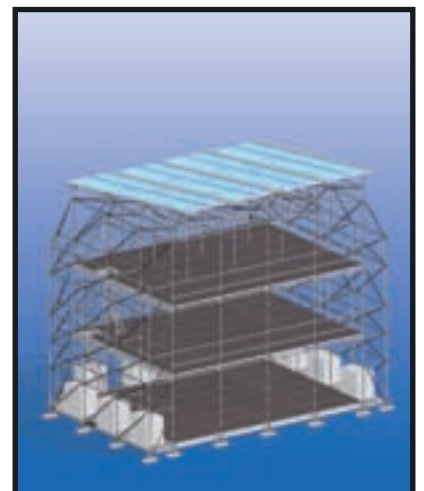

FOH tower 8 x 6 – 3 levels

- ▶ Permissible load capacity: lowest level 7.5 kN/m², other levels 2.0 kN/m².
- ▶ Inspection book with structural strength computation according to requirements and standards is available!
- ▶ 3-sided cladding possible and included in strength computation.
- ▶ Low storey height of 2.50 m thanks to the new Layher FOH beam.

Layher FOH Tower

Technology, accessories and KITS.

25



FOH tower Complete KITS

System EV 104:

KIT 5060401	4.14 x 4.14 x	2.50 m	1 level
KIT 5060402	4.14 x 4.14 x	5.00 m	2 levels
KIT 5060403	4.14 x 4.14 x	7.50 m	3 levels
KIT 5060405	6.21 x 4.14 x	2.50 m	1 level
KIT 5060406	6.21 x 4.14 x	5.50 m	2 levels
KIT 5060407	6.21 x 4.14 x	7.50 m	3 levels
KIT 5060409	8.28 x 4.14 x	2.50 m	1 level
KIT 5060410	8.28 x 4.14 x	5.50 m	2 levels
KIT 5060411	8.28 x 4.14 x	7.50 m	3 levels
KIT 5060413	6.21 x 6.21 x	2.50 m	1 level
KIT 5060414	6.21 x 6.21 x	5.50 m	2 levels
KIT 5060415	6.21 x 6.21 x	7.50 m	3 levels
KIT 5060417	8.28 x 6.21 x	2.50 m	1 level
KIT 5060418	8.28 x 6.21 x	5.50 m	2 levels
KIT 5060419	8.28 x 6.21 x	7.50 m	3 levels

System EV 100:

KIT 5060001	4.00 x 4.00 x	2.50 m	1 level
KIT 5060002	4.00 x 4.00 x	5.00 m	2 levels
KIT 5060003	4.00 x 4.00 x	7.50 m	3 levels
KIT 5060005	6.00 x 4.00 x	2.50 m	1 level
KIT 5060006	6.00 x 4.00 x	5.00 m	2 levels
KIT 5060007	6.00 x 4.00 x	7.50 m	3 levels
KIT 5060009	8.00 x 4.00 x	2.50 m	1 level
KIT 5060010	8.00 x 4.00 x	5.00 m	2 levels
KIT 5060011	8.00 x 4.00 x	7.50 m	3 levels
KIT 5060013	6.00 x 6.00 x	2.50 m	1 level
KIT 5060014	6.00 x 6.00 x	5.00 m	2 levels
KIT 5060015	6.00 x 6.00 x	7.50 m	3 levels
KIT 5060017	8.00 x 6.00 x	2.50 m	1 level
KIT 5060018	8.00 x 6.00 x	5.00 m	2 levels
KIT 5060019	8.00 x 6.00 x	7.50 m	3 levels

FOH beam 4.00 / 4.14 m

- ▶ This new development specially for FOH towers is distinguished by an extremely low height, and can span two bays. As a result, a 2.50 m storey height is sufficient at the lower level, and there is no Allround support in the way of the mixing consoles.



Event access hatch 2.00 / 2.07 m

- ▶ This special access deck was designed to match the Event System, for effortless and safe internal access. It is designed symmetrical, so it can be fitted in the tower as and where required. Available for all Layher Event Systems.



Roofs

- ▶ For roofing your FOH tower, there are various systems available – the extremely attractive lightweight cassette roof (see photo), a complete tarpaulin hood or the proven keder sheet system.



The specified surfaces are usable ones, without ballasting bays. For ballasting and stiffening the entire structure, a bay of 1.04 m or 1.00 m is required on each of the 3 sides, depending on the construction height!

Layher Camera Towers

Stability at the highest level.

26

The new product line of camera towers from Layher, which can be alternatively used as lighting towers too, offers you maximum stability and – when your Event decks are used too – a work platform noteworthy for outstanding strength.



Camera tower based on Layher Allround equipment!

Camera tower Complete KITS

System EV 86

KIT 5078601	Camera	2.57 x 2.07 m	Height 2.20 m
KIT 5078602	Camera	2.57 x 2.07 m	Height 3.20 m
KIT 5078603	Camera	2.57 x 2.07 m	Height 4.20 m
KIT 5078604	Camera	2.57 x 2.07 m	Height 5.20 m
KIT 5078605	Camera	2.57 x 2.07 m	Height 6.20 m

System EV 100

KIT 5070001	Camera	2.00 x 2.00 m	Height 2.20 m
KIT 5070002	Camera	2.00 x 2.00 m	Height 3.20 m
KIT 5070003	Camera	2.00 x 2.00 m	Height 4.20 m
KIT 5070004	Camera	2.00 x 2.00 m	Height 5.20 m
KIT 5070005	Camera	2.00 x 2.00 m	Height 6.20 m

System EV 104

KIT 5070401	Camera	2.07 x 2.07 m	Height 2.20 m
KIT 5070402	Camera	2.07 x 2.07 m	Height 3.20 m
KIT 5070403	Camera	2.07 x 2.07 m	Height 4.20 m
KIT 5070404	Camera	2.07 x 2.07 m	Height 5.20 m
KIT 5070405	Camera	2.07 x 2.07 m	Height 6.20 m

A complete inspection book is available for all variants!



Lighting towers

- ▶ Highly versatile, since camera towers can also be used as lighting towers.
- ▶ Very simple and fast assembly.
- ▶ Very high stability.
- ▶ Outstanding appearance.

For all Event Systems

- ▶ With the camera towers product line, we offer you the ideal solution for all requirements and wishes.
- ▶ If required also available with roof and side panels.

Roofs

- ▶ Regardless of whether it's indoors or outdoors, here too you can choose from a number of variants for the roof.
- ▶ There are tried and tested systems with keder tarpaulins, a complete tarpaulin hood or the modern, lightweight and attractive lightweight cassette roof to choose from.

Layher Stage Direction Towers

When full view is crucial.

27

A full view and a safe place to work from – those are the crucial criteria if you're directing. This new product line provides both: a place to work that's safe for you even at dizzy heights and that offers the best view too. A system with (almost) unlimited possibilities!



Directing towers based on Layher Allround equipment!

Any construction forms I

- ▶ If the available space is insufficient for one of the already calculated KIT variants, the construction forms can – as shown on the photo – also be adapted.
- ▶ The Layher Allround equipment allows you and your imagination to create almost any form.



Any construction forms II

- ▶ In the same way as the camera towers, Layher offers you a wide range of already calculated KITS for directing towers.
- ▶ The required form can also diverge from these KITS or be used in a combination – for example with double width. That's top flexibility.



Protect system

- ▶ With the Layher Protect system, valuable equipment is protected from the weather and from unauthorised access.
- ▶ Individual protective panels can be assembled from a large number of components.
- ▶ Optionally with doors and glass elements too.



Stage Direction Towers Complete KITS

System EV 86

KIT 5088601	Stage Direction	2.57 x 4.14 m	Height 2.20 m
KIT 5088602	Stage Direction	2.57 x 4.14 m	Height 3.20 m
KIT 5088603	Stage Direction	2.57 x 4.14 m	Height 4.20 m
KIT 5088604	Stage Direction	2.57 x 4.14 m	Height 5.20 m
KIT 5088605	Stage Direction	2.57 x 4.14 m	Height 6.20 m

System EV 100

KIT 5080001	Stage Direction	2.00 x 4.00 m	Height 2.20 m
KIT 5080002	Stage Direction	2.00 x 4.00 m	Height 3.20 m
KIT 5080003	Stage Direction	2.00 x 4.00 m	Height 4.20 m
KIT 5080004	Stage Direction	2.00 x 4.00 m	Height 5.20 m
KIT 5080005	Stage Direction	2.00 x 4.00 m	Height 6.20 m

System EV 104

KIT 5080401	Stage Direction	2.07 x 4.14 m	Height 2.20 m
KIT 5080402	Stage Direction	2.07 x 4.14 m	Height 3.20 m
KIT 5080403	Stage Direction	2.07 x 4.14 m	Height 4.20 m
KIT 5080404	Stage Direction	2.07 x 4.14 m	Height 5.20 m
KIT 5080405	Stage Direction	2.07 x 4.14 m	Height 6.20 m

A complete inspection book is available for all variants!

Layher PA Wings and Attachments

Lend your PA's wings.

28

PA wings made from Layher Allround equipment have long been a classic feature in stage construction. Thanks to their modular design, they can be adapted to almost any construction size and be firmly connected to the stage. At the same time they can be extended for use as a roof holder and as a storage centre.



PA wings based on Layher Allround equipment!

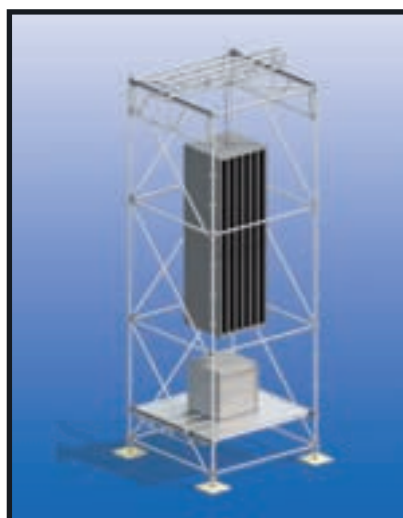

PA Wing 2 x 2

- ▶ 2 x 2 m in size, up to a height of 6.00 m, available as already calculated KITS (Event Systems EV 100 and EV 104).
- ▶ The Event crosspiece in System 29/4 allows loads in the bay centre of up to 1000 kg.

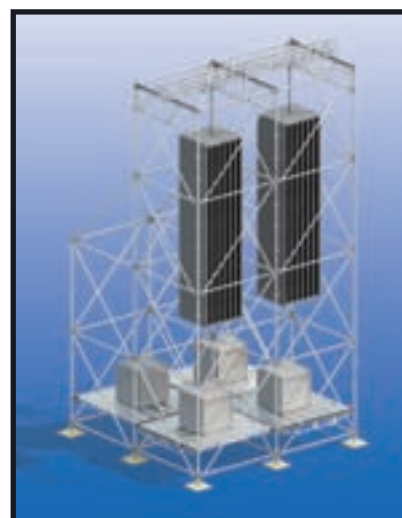

PA Wing 4 x 4

- ▶ 4 x 4 m in size, up to a height of 12.00 m, available as already calculated KITS (Event Systems EV 100 and EV 104).
- ▶ The Event crosspiece in System 29/4 allows loads in the bay centre of up to 2000 kg.

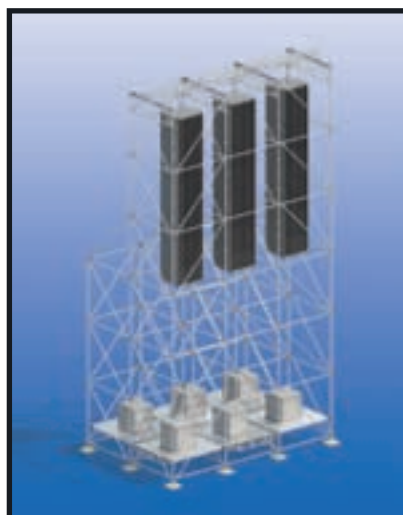

PA Wing 6 x 4

- ▶ 6 x 4 m in size, up to a height of 12.00 m, available as already calculated KITS (Event Systems EV 100 and EV 104).
- ▶ The Event crosspiece in System 29/4 allows loads in the bay centre of up to 3000 kg.

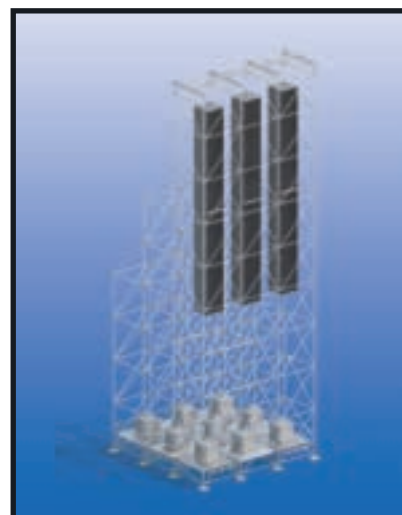

PA Wing 6 x 6

- ▶ 6 x 6 m in size, up to a height of 18.00 m, available as already calculated KITS (Event Systems EV 100 and EV 104).
- ▶ The Event crosspiece in System 29/4 allows loads in the bay centre of up to 3000 kg.

Layher PA Wings and Attachments

Technology, accessories and KITS.

29

- ▶ Event solutions of superb quality.
- ▶ Camera pits for a platform about 30 - 50 cm underneath the stage.
- ▶ Storage centre and loading docks at stage level for offloading and interim storage of the tour equipment.
- ▶ Technical centre for all technical systems near the stage.



PA Wings Complete KITS

PA Wings LAYHER dimensions

KIT 5090401	PA Wing	2.07 x 2.07 x 4.20 m
KIT 5090402	PA Wing	2.07 x 2.07 x 5.20 m
KIT 5090403	PA Wing	2.07 x 2.07 x 6.20 m
KIT 5090404	PA Wing	4.14 x 2.07 x 4.20 m
KIT 5090405	PA Wing	4.14 x 2.07 x 5.20 m
KIT 5090406	PA Wing	4.14 x 2.07 x 6.20 m
KIT 5090407	PA Wing	4.14 x 4.14 x 8.20 m
KIT 5090408	PA Wing	4.14 x 4.14 x 10.20 m
KIT 5090409	PA Wing	4.14 x 4.14 x 12.20 m
KIT 5090410	PA Wing	6.21 x 4.14 x 8.20 m
KIT 5090411	PA Wing	6.21 x 4.14 x 10.20 m
KIT 5090412	PA Wing	6.21 x 4.14 x 12.20 m
KIT 5090413	PA Wing	6.21 x 6.21 x 14.20 m
KIT 5090414	PA Wing	6.21 x 6.21 x 16.20 m
KIT 5090415	PA Wing	6.21 x 6.21 x 18.20 m

PA Wings METRIC dimensions

KIT 5090001	PA Wing	2.00 x 2.00 x 4.20 m
KIT 5090002	PA Wing	2.00 x 2.00 x 5.20 m
KIT 5090003	PA Wing	2.00 x 2.00 x 6.20 m
KIT 5090004	PA Wing	4.00 x 2.00 x 4.20 m
KIT 5090005	PA Wing	4.00 x 2.00 x 5.20 m
KIT 5090006	PA Wing	4.00 x 2.00 x 6.20 m
KIT 5090007	PA Wing	4.00 x 4.00 x 8.20 m
KIT 5090008	PA Wing	4.00 x 4.00 x 10.20 m
KIT 5090009	PA Wing	4.00 x 4.00 x 12.20 m
KIT 5090010	PA Wing	6.00 x 4.00 x 8.20 m
KIT 5090011	PA Wing	6.00 x 4.00 x 10.20 m
KIT 5090012	PA Wing	6.00 x 4.00 x 12.20 m
KIT 5090013	PA Wing	6.00 x 6.00 x 14.20 m
KIT 5090014	PA Wing	6.00 x 6.00 x 16.20 m
KIT 5090015	PA Wing	6.00 x 6.00 x 18.20 m

Loading docks LAYHER/METRIC dimensions

KIT 5100401	Loading Dock	4.14 x 4.14 x 0.80 m
KIT 5100402	Loading Dock	4.14 x 4.14 x 1.30 m
KIT 5100403	Loading Dock	4.14 x 4.14 x 1.80 m
KIT 5100001	Loading Dock	4.00 x 4.00 x 0.80 m
KIT 5100002	Loading Dock	4.00 x 4.00 x 1.30 m
KIT 5100003	Loading Dock	4.00 x 4.00 x 1.80 m

A complete inspection book is available for all variants!

Light tower

- ▶ PA wings from Layher can do a lot more than hang your speakers. For example, the towers based on Layher Allround equipment are also often used for lighting. The variability of this system makes it very easy for you to implement your ideas.



Camera pit

- ▶ Camera pits can be connected to the stage structure and offer maximum stability – no camera can wobble, particularly since the Layher Event decks permit only very slight sagging when subjected to loads.



Loading docks

- ▶ Loading and offloading of the trailers is made extremely easy by the combination of loading docks, stairways or ramps.
- ▶ For the loading docks there are finished KITS based on the Event construction kits; these can be also be made up to suit individual needs.



Layher Stairway Systems

The entry ticket to your event.

30

With the stairway systems from Layher, you gain access to all stages, stands and other event venues – with guaranteed safety and maximum flexibility. Flexible or modular solutions are available for every requirement and to cope with very high loads.



Stairway systems based on Layher Allround equipment!

Stairway systems Complete KITS

KIT 5114200	Flex stairway 4-step	2.00 m PO System
KIT 5115200	Flex stairway 5-step	2.00 m PO System
KIT 5114207	Flex stairway 4-step	2.07 m PO System
KIT 5115207	Flex stairway 5-step	2.07 m PO System

KIT 5124200	Flex stairway 4-step	2.00 m EV System
KIT 5125200	Flex stairway 5-step	2.00 m EV System
KIT 5124207	Flex stairway 4-step	2.07 m EV System
KIT 5125207	Flex stairway 5-step	2.07 m EV System

KIT 5132200	Modular stairway 750	2-step 2.00 m
KIT 5133200	Modular stairway 750	3-step 2.00 m
KIT 5134200	Modular stairway 750	4-step 2.00 m
KIT 5135200	Modular stairway 750	5-step 2.00 m
KIT 5136200	Modular stairway 750	6-step 2.00 m
KIT 5137200	Modular stairway 750	7-step 2.00 m
KIT 5138200	Modular stairway 750	8-step 2.00 m
KIT 5139200	Modular stairway 750	9-step 2.00 m

KIT 5132207	Modular stairway 750	2-step 2.07 m
KIT 5133207	Modular stairway 750	3-step 2.07 m
KIT 5134207	Modular stairway 750	4-step 2.07 m
KIT 5135207	Modular stairway 750	5-step 2.07 m
KIT 5136207	Modular stairway 750	6-step 2.07 m
KIT 5137207	Modular stairway 750	7-step 2.07 m
KIT 5138207	Modular stairway 750	8-step 2.07 m
KIT 5139207	Modular stairway 750	9-step 2.07 m



Stairway tower 750

- ▶ Special stairway tower for the World Cup 2006 in Germany using System 750.
- ▶ Designed for maximum load capacity of 750 kg/m².
- ▶ Meets with the stairway rise of 166 mm all requirements of MVStättV regulations.



Bridging

- ▶ Bridging for world skiing championships in Oberhof using System 500 (maximum load capacity 500 kg/m²).
- ▶ Stairway rise of 200 mm.
- ▶ This system is also suitable to provide access to stages and podiums.



Modular stairway 750

- ▶ The particularly clever stairway system for stages.
- ▶ Expandable step by step.
- ▶ The permissible load is 750 kg/m².
- ▶ Stairway of 1, 2 and 3-stepped elements adaptable to the height of the stage or stand – regardless of the deck.

Layher Ramp Systems

The clever (TRAN)SPORT systems.

31

You can with only a few expansion parts use your Event construction kit to build a wide range of ramps: loading and transport ramps, ramps for wheelchair users or even ramps for extreme sporting events – skiing, snowboarding, tobogganing or BMX – Layher has the right solution for every event.



Ramp system based on Layher Allround equipment!



Ramps Complete KITS

Snowboard ramp

- ▶ Based on Layher Allround equipment, skiing or snowboarding ramps can be built in nearly any shape.
- ▶ Smaller ramps are used for long-distance skiing and for BMX racing.



Loading ramp 13°

- ▶ These practical ramps can be made easily using standard material.
- ▶ The crosswise-installed sections also enable very narrow transport ramps to be built when this is necessary for space reasons.
- ▶ Design with simple guard rails made from Allround ledgers, or with child safety device.



Wheelchair ramp 6°

- ▶ The swivelling spindles and the special base collars with 2 and 3 rosettes permit precise setting of the ramp rise to 6°.
- ▶ Usable for all Event Systems.



KIT 5168601	Ramp 6° EV 86	Height 0.50 m
KIT 5168602	Ramp 6° EV 86	Height 0.75 m
KIT 5168603	Ramp 6° EV 86	Height 1.00 m
KIT 5168604	Ramp 6° EV 86	Height 1.25 m
KIT 5168605	Ramp 6° EV 86	Height 1.50 m
KIT 5160001	Ramp 6° EV 100	Height 0.50 m
KIT 5160002	Ramp 6° EV 100	Height 0.75 m
KIT 5160003	Ramp 6° EV 100	Height 1.00 m
KIT 5160004	Ramp 6° EV 100	Height 1.25 m
KIT 5160005	Ramp 6° EV 100	Height 1.50 m
KIT 5160401	Ramp 6° EV 104	Height 0.50 m
KIT 5160402	Ramp 6° EV 104	Height 0.75 m
KIT 5160403	Ramp 6° EV 104	Height 1.00 m
KIT 5160404	Ramp 6° EV 104	Height 1.25 m
KIT 5160405	Ramp 6° EV 104	Height 1.50 m
KIT 5178601	Ramp 13° EV 86	Height 0.50 m
KIT 5178602	Ramp 13° EV 86	Height 1.00 m
KIT 5178603	Ramp 13° EV 86	Height 1,50 m
KIT 5170001	Ramp 13° EV 100	Height 0.50 m
KIT 5170002	Ramp 13° EV 100	Height 1,00 m
KIT 5170003	Ramp 13° EV 100	Height 1.50 m
KIT 5170401	Ramp 13° EV 104	Height 0.50 m
KIT 5170402	Ramp 13° EV 104	Height 1.00 m
KIT 5170403	Ramp 13° EV 104	Height 1.50 m

Layher Event Accessories

Systems and assistants for every event.

32

With our product groups Allround, Accessories and Protect Systems, you can plan numerous structures to cater for your event. To help you to assemble everything safely, we can also offer you the right ladders and rolling towers in the familiar Layher quality.



Layher Allround Scaffolding

- ▶ The unique modular scaffolding system for all ambitious structures
- ▶ Approval for steel: Z-8.22-64
- ▶ Approval for aluminium: Z-8.22-64.1
- ▶ Very rapid assembly thanks to non-bolted connections
- ▶ Particularly low weight of individual components
- ▶ Persuasive in its profitability and flexibility



Layher Logistic Systems

Logistic solutions for optimising storage and transport, for example:

- ▶ 5111.125 Universal pallet 125
- ▶ 5105.085 Tube pallet 85
- ▶ 5105.125 Tube pallet 125
- ▶ 5113.265 Tube pallet 265
- ▶ 5113.000 Modular skeleton box and further pallets for all event and scaffolding construction components.

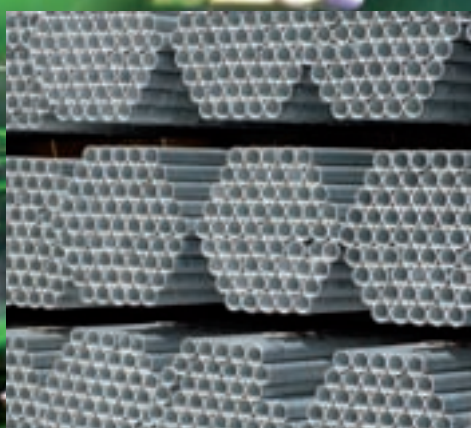

Layher Event Accessories

Systemfree accessories for all Event structures, for example:

- ▶ base plates 40/ 60/ 80
- ▶ aluminium tubes 48.3 x 4.0 mm
- ▶ steel tubes 48.3 x 4.0 mm
- ▶ and numerous couplers for all applications



Layher ladders and rolling towers

- ▶ High-quality and absolutely stable professional ladders made of aluminium, wood or composite ladders in all standard variants incl. 5-year Layher warranty.
- ▶ Rolling towers in the familiar Layher quality for heights of up to 13.60 m.
- ▶ Outstanding workmanship and stability, including TÜV and GS symbols.

Layher Event Accessories

Systems and assistants for every event.

33

Separate catalogues and price lists are available for all the product groups described!



Layher Protect System

- ▶ The high-quality and highly attractive system for enclosures.
- ▶ Available in various lengths and designs.
- ▶ Heights up to 90 m.
- ▶ Sound insulation value up to 26 dB.
- ▶ Ideal for use in the events field.



Layher Keder Roof System

- ▶ Lightweight and very attractive weather protection roof for spans of up to 18.00 m.
- ▶ Can be used for mono-pitch and double-pitch roofs, suitable keder rails and flexible arches are available for the side panels.
- ▶ Assembly without crane is possible.



Layher Lightweight Cassette Roof System

- ▶ The beautiful system for roofs, with spans of up to 28.91 m being possible.
- ▶ Remarkably light, stable and safe.
- ▶ Ideal for use in FOH, camera and directing towers.
- ▶ Very easy assembly without crane is possible.



Layher Cassette Roof System

- ▶ The proven and very strong system for spans of up to 27.10 m.
- ▶ Can be built as a mono-pitch or double-pitch roof up to 0.75 kN/m².

Simply More Possibilities with Layher Event Systems

34

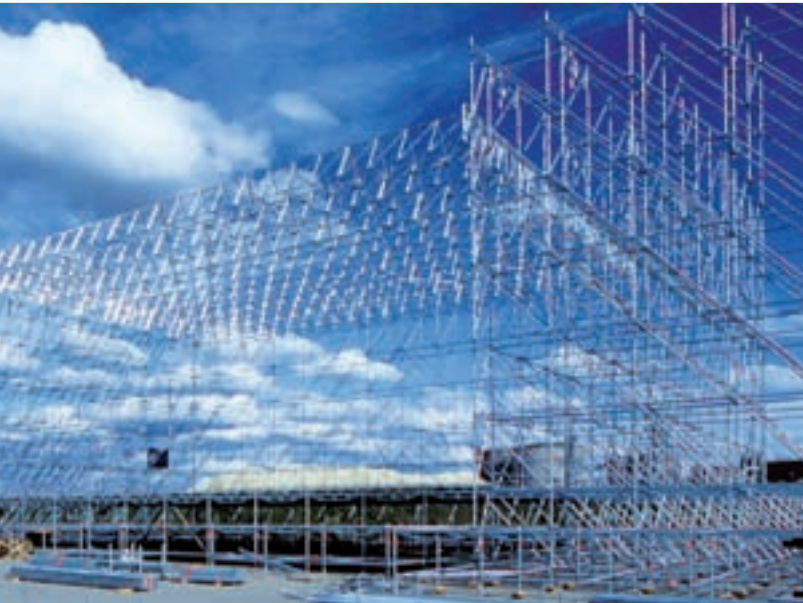





Layher® 

More Possibilities. The Scaffolding System.

Wilhelm Layher GmbH & Co. KG
Scaffoldings Grandstands Ladders

Ochsenbacher Strasse 56
D-74363 Gueglingen-Eibensbach

Post Box 40
D-74361 Gueglingen-Eibensbach

Phone +49 (0) 71 35 70 - 0
Fax +49 (0) 71 35 70 - 265
E-Mail export@layher.com
www.layher.com